

Traditional Wall Base and TightLock® Wall Base Systems



A part of **ReStart®** program



Phthalate free, except for recycled materials



FloorScore® certified and meets CA 01350*

Recycled Content
Pre-consumer 14%



TVOC ≤ 100 µg/m³

adhesives pg. 196

**Traditional Vinyl + Rubber Wall Base.
Keep it simple.**

We know there's a time and a place for straightforward, no-nonsense options. That's why our Traditional Wall Base is basic, but better. With durable construction and multiple options for height and color, our Traditional Wall Base has everything you need. And nothing you don't.

TRADITIONAL

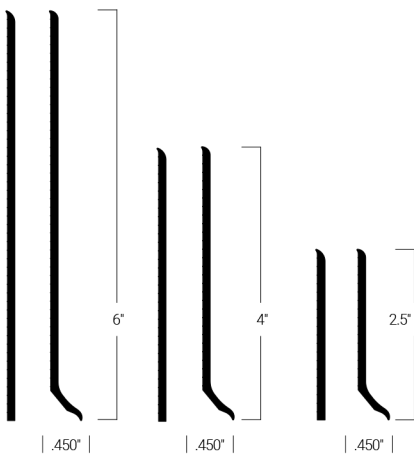

3 standard heights: 2.5" (64 mm), 4" (102 mm), 6" (153 mm) or 4.5" (114 mm) inDC only

Available in Duracove Rubber (type TP) 1/8" (3.175 mm) and vinyl (type TV) .080" (2 mm) or 1/8" (3.175 mm)

Standard heights available in toe or toeless

4' sections and coils available

Manufactured inside and outside corners available

4.5", 8", 9" and 10" heights are special order; call for details

4.5" in Duracove only

Traditional Wall Base and TightLock® Wall Base Systems



A part of **ReStart®** program



Phthalate free, except for recycled materials



FloorScore® certified and meets CA 01350*

Recycled Content
Pre-consumer 14%



TVOC ≤ 100 µg/m3

adhesives pg. 196

TightLock® Wall Base System. U.S. Patent No. 5,212,923
Lock it up.

When we say TightLock® Carpet Base comes first, it really does. Its notched design allows it to be installed before the carpeting and carpet tile, and remain in place when changing out the flooring too. This saves time and money on re-installation and wall repairs. Plus, this durable, high-performance base can stay in place longer, making it a more sustainable choice. Also available in a Resilient Base, TightLock provides a cove base look with a more subtle radius. With a unique tapered design, the resilient base accommodates any commercial flooring and delivers a tight, clean, finished appearance year after year.

TIGHTLOCK CARPET

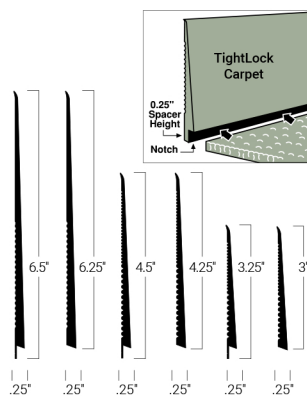

TIGHTLOCK RESILIENT

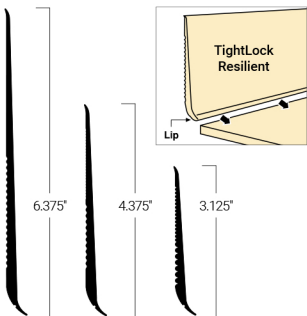

See Color Guide for Availability

4' sections or 75' coils

Manufactured outside corners available

Clean, toeless look

More resistant to damage and distortion from maintenance equipment and chairs

TightLock for carpet

3.25" (83 mm), 3" (76 mm) face
4.5" (114 mm), 4.25" (108 mm) face
6.5" (165 mm), 6.25" (159 mm) face

TightLock for resilient flooring

3.125" (79 mm)
4.375" (111 mm)
6.375" (162 mm)

Millwork



FloorScore® certified and meets CA 01350*



Ortho-Phthalate Free except for recycled materials



A part of ReStart® program



TVOC ≤ 100 µg/m³

Recycled Content Pre-consumer 14%

All covered.

The Millwork® Wall Finishing System eliminates concerns of mismatched wood or color variation. With more than 20 coordinating elements, Tarkett can help you cover your bases completely and

consistently from batch to batch and year to year. Choose from contoured wall base profiles, a chair rail profile, a corner guard, self-stick quarter round and shoe moulding.

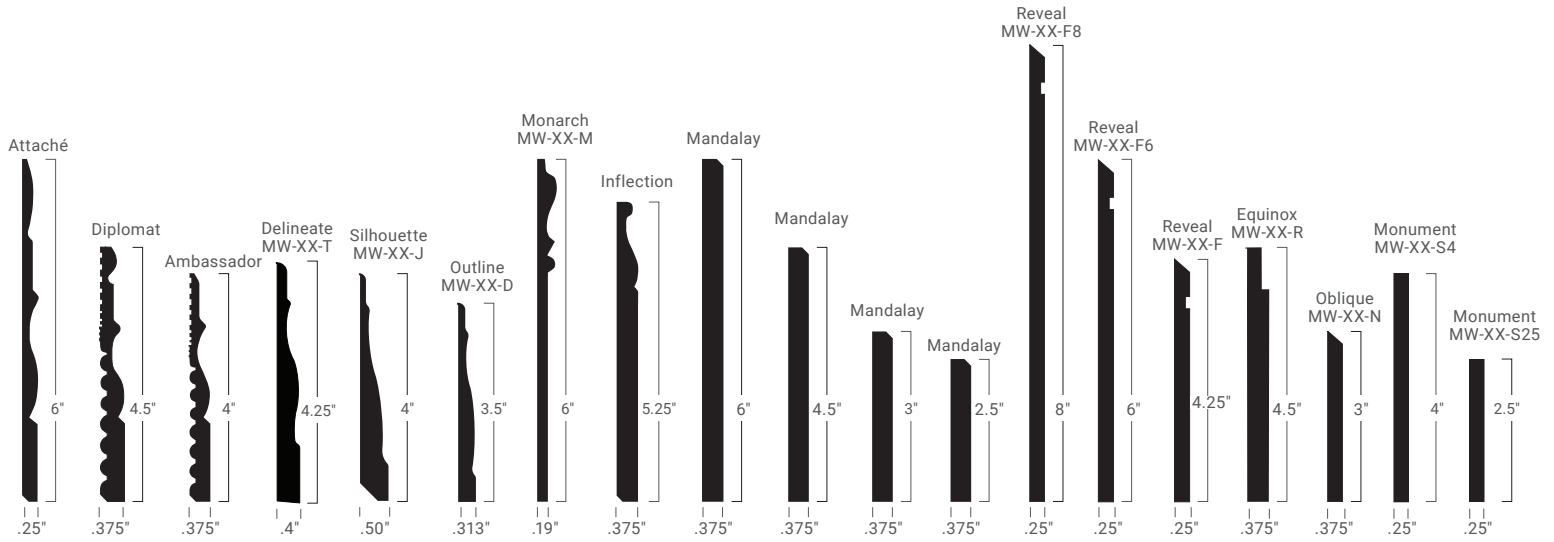

All Millwork profiles in wall base, chair rails and corner guard are available in standard 8' lengths.

MILLWORK CHAIR RAIL



RAMPART
CHR-XX-C
Recommended Millwork Masquerade profile

MILLWORK CORNER GUARD

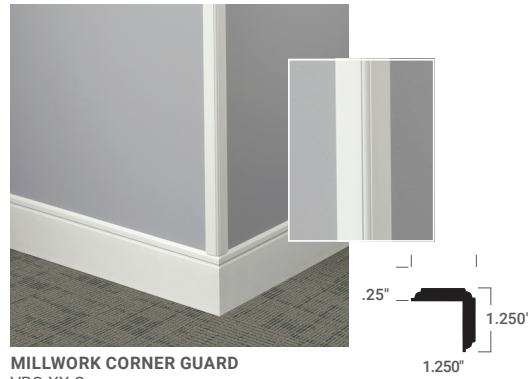

MILLWORK CORNER GUARD
VBG-XX-C

MILLWORK ACCESSORIES



QUARTER ROUND
QTR-XX-A, QTR-XX-D

MILLWORK ACCESSORIES



SHOE Moulding
SHU-XX-A

Millwork

Color Palette Availability

Millwork is available in all solid colors plus 00 unfinished.

M Available in Masquerade Palette



ATTACHÉ
MW-XX-E



DIPLOMAT[®]
MW-XX-A



SILHOUETTE[®]
MW-XX-J

M



DELINEATE
MW-XX-T



OUTLINE[®]
MW-XX-D

U.S. PATENT
NO. D484,254

M



AMBASSADOR
MW-XX-K

U.S. PATENT
NO. D500,149



INFLECTION
MW-XX-G

U.S. PATENT
NO. D499,193



EQUINOX
MW-XX-R



OBLIQUE
MW-XX-N

M



MANDALAY
4.5" MW-XX-H
2.5" MW-XX-H25
3" MW-XX-H3
6" MW-XX-H6

U.S. PATENT
NO. D493,895



REVEAL[®]
4.25" MW-XX-F
6" MW-XX-F6
8" MW-XX-F8

U.S. PATENT NO.
D484,253; D510,145

M

Recommended Millwork Masquerade[®] profile



MONARCH
6" MW-XX-M



MONUMENT[®]
2.5" MW-XX-S25, 4" MW-XX-S4

Color Foundations

Foundations is our commitment to always have representation across 6 key neutral palettes. For our complete color offering, reference color guide in back.

We've identified Color Foundations neutrals in the following way: **WB** (warm beige),

CB (cool beige), **WG** (warm grey), **CG** (cool grey), **B** (black), **W** (white).

Millwork

SOLID COLORS

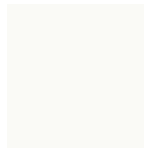

08 Icicle W

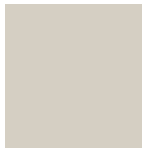

24 Grey Haze WG



55 Silver Grey WG

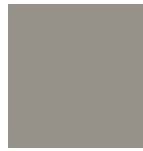

32 Pebble WG

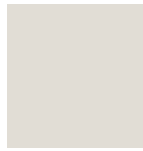

460 Cotton W

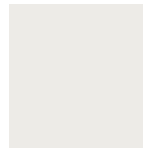

27 Mist WG



TG5 Macadamia WG



150 Wetlands

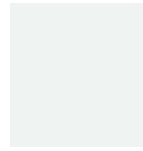

50 White W



29 Moon Rock WG



48 Grey WG



20 Charcoal WG



TA4 Gateway WG

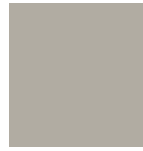

469 Mystify CG



VN2 Stone Cottage WG



281 Grizzly CB



VK7 Mt Rainier WG



199 Dockside WG

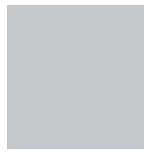

21 Platinum CG

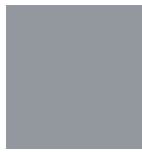

38 Pewter CG



28 Medium Grey CG



71 Storm Cloud CG



TG6 Mink WG



197 Shaded WG

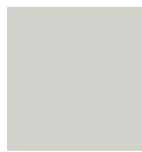

TB3 Dover CG



23 Vapor Grey CG



TG2 Shark Fin CG

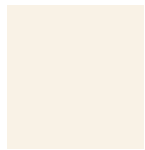

01 Snow White W

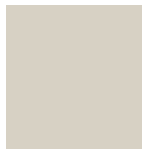

22 Pearl CB



31 Zephyr CB



80 Fawn CB



TG3 Iron Mountain CG



VN1 White Slipper W



TA5 Colonial Grey CG



262 Drizzle CG



VL4 Cool Metal CG



11 Canvas WB



49 Beige WB



TA8 Welsh Castle CB



283 Toast

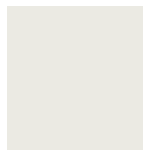

TG1 Snowbound W



VK8 Sandstorm CB



VL2 Whispering Mist CB



VL1 Harvest Time CB



121 Cement CB



09 Clay WB



45 Sandalwood WB



76 Cinnamon



47 Brown



TA3 Castaway CB



280 Shoreline



101 Seaweed

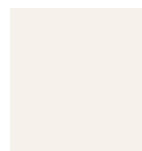

68 White Sand W



194 Antique White W



TB1 Peppercorn



167 Fudge



44 Dark Brown B



63 Burnt Umber B



129 Silk WB



461 Wicker WB



79 Bone White W



34 Almond W



TA1 Tannery



86 Hunter Green



18 Navy Blue



TA6 Bedrock CG



40 Black B



130 Sisal

COLORMATCH®

All colors shown in this card, including chips and photographs, approximate the actual flooring colors as accurately as possible.

Millwork

SOLID COLORS



151 Iguana



VN3 Gecko



264 Grounded



TB2 Boxwood



282 Vaporize

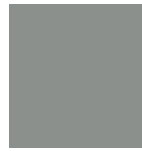

VM4 Green Smoke



VN4 Green Vista



168 Thunder



TH1 Glenhaven



VL8 Grinch



VM5 Dream Teal



72 Harbour



58 Windsor Blue



VN5 The Blues



84 Blue Jeans



92 Blue Lagoon



TH3 Inkwell



TA9 Indigo



TH2 Blue Intensity



TB4 Grapest



TG9 Poetry Plum

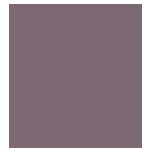

VM2 Shoreline Purple



VM3 Misted Plum

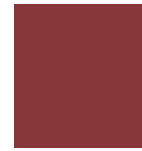

163 Salsa



TG7 Canary



VM8 Mr Sunshine



VM1 Hot Spice



62 Tangerine Tango



TG8 Spicy Chip



VL9 Red Clay



VL7 Sailor Red

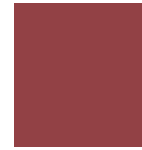

TB6 Flame



107 Neutrality



TA7 Rusty Nail



132 Espresso



85 Burgundy



TA2 Saddlebrook



284 Ganache

METALLIC COLORS

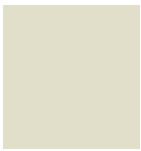

77 White Pearl W



67 Old Gold



176 Brass WB



66 Either Ore



179 Steel WG



69 Sterling Silver CG

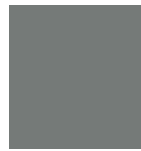

178 Ironstone CG



82 Black Pearl B

Color plays a key role in interior design and the Tarkett Solution SPECtrum™. By coordinating all flooring and accessory solutions across a balanced, harmonized palette, we've combined simplicity with creative freedom to help you create beautiful, productive spaces.

The palette is organized with our Color Foundations system, which helps you coordinate colors across the entire Tarkett portfolio. There are hundreds of choices in six neutral palettes and one guarantee: you'll always have color coordinating options within each palette, now and into the future. Guaranteed.

Key: WB (Warm Beige), CB (Cool Beige), WG (Warm Grey), CG (Cool Grey), B (Black), W (White)

Customization:

When you don't see the exact color you need, create it. We offer customized colors with quick lead times and low minimums. Contact your local Tarkett representative to get started.

ColorMatch®:

This designer palette of leading colors is coordinated across multiple product categories with no dye lots... ever! Our rigorous manufacturing and quality standards enable you to confidently mix and match a color across all Johnsonite rubber flooring products, finishing borders and finishing accessories.

1. PROPRIETARY PRODUCT/MANUFACTURER

1.1. **Proprietary Product:** Tarkett MetalEdge resilient transitional mouldings that are A.D.A. Compliant..

1.2. Manufacturer:

Tarkett North America Phone (800) 899-8916
30000 Aurora Rd.
Solon, Ohio 44139
Web: www.tarkettna.com
E-mail: info@tarkett.com

1.3. Proprietary Product Description:

1.3.1. **Construction:** Tarkett MetalEdge resilient transitional mouldings are manufactured from a homogeneous composition of polyvinyl chloride (PVC), high quality additives, and colorants. All transitional mouldings comply with A.D.A. requirements of Section 4.5.2 *Changes of Level*. Tarkett transitional mouldings are designed for interior applications only.

1.3.2. Styles:**• ME001:**

- 0.120" (3.0mm) LVT materials to carpet with total thickness of 0.21" (5.3mm) to 0.25" (6.4mm), 0.18" (4.6mm) cap with 0.13" (3.2mm) wide support

• MET02:

- 0.120"(3.0mm) LVT Materials to carpet with total thickness of up to 0.21" (5.2mm), 0.18" (4.6mm) cap with 0.13" (3.2mm) wide support
- **This piece also serves as MetalEdge Trim:** Edge trim for Ethos Modular not installed wall-to-wall – see installation instructions for details.

• ME003: Use in conjunction with **ME004**

- 0.120" (3.0mm) LVT to carpet with a total thickness of 0.26" (6.5mm) or greater, 0.25" (6.35mm) cap with 0.13" (3.18mm) wide support

1.3.3. Physical Characteristics**• Length:**

- **ME001, MET02, ME003** – 12ft (3.66m)
- **ME004** – 4ft (1.22m)

• Packaging:

- **ME001, MET02, ME003** – 25 pieces per carton
- **ME004** – 10 pieces per carton

2. PERFORMANCE AND TECHNICAL DATA

- **Slip Resistance (ASTM D 2047):** Exceeds Federal Standards and A.D.A. recommendations
- **Fire Resistance (ASTM E 648 / NFPA 253 Critical Radiant Flux):** Class 1

3. INSTALLATION

3.1 See Tarkett MetalEdge & MetalEdge Trim installation instructions for complete details.

3.2 Adhesives:**• Tarkett RollSmart™ Adhesive:**

Application: 3/8" nap paint roller
Approximate coverage: POROUS & NON-POROUS
350 - 400 sq. ft. per gallon

• Tarkett 959™ Adhesive:

Application: 1/16x1/16x1/16 V notch trowel
Approximate Coverage:
POROUS: 150 - 175 sq. ft. per gallon
NON POROUS: 250 - 300 sq. ft. per gallon

• Tarkett 946™ Premium Contact Adhesive

Application: Basting Brush
Approximate Coverage: POROUS & NON-POROUS
24-36 sq ft per 1 QT / 144-215 sq ft per 1 GAL

• Tarkett 975™ Two-Part Polyurethane Adhesive:

Application: 1/32x1/16x1/32 U notch trowel
Approximate Coverage: POROUS & NON-POROUS
225 - 250 sq. ft. per gallon

• Tarkett Power Tape™ (ethos Modular Only)

1 ½"x164 lf per roll

4. AVAILABILITY AND COST

Available through authorized Tarkett distributors nationwide.

5. MAINTENANCE

72 hours after installation is completed, initial maintenance procedures must be implemented in accordance with manufacturer's requirements. Refer to Tarkett maintenance instructions for complete maintenance details.

6. TECHNICAL SERVICES

Visit us on the web at www.tarkettna.com
Contact Technical Support at (800) 899-8916 or E-mail:
Resilient.TechnicalSupport@Tarkett.com

Samples: Submittal samples for verification and approval

available upon request from Tarkett. Samples shall be submitted in compliance with the requirements of the contract documents. Accepted and approved samples shall constitute the standard materials which represent materials installed on the project.

7. LIMITED WARRANTY

Limited 20 year warranty. For complete details, contact Tarkett or an authorized Tarkett distributor.

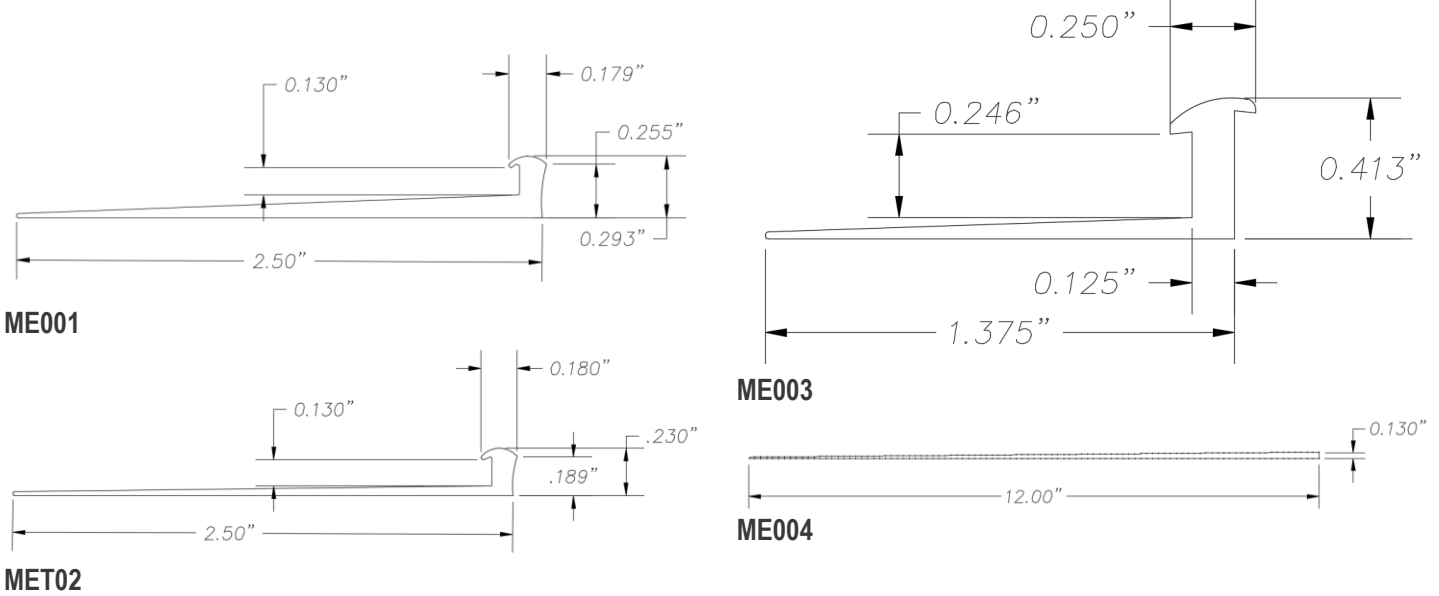

Tarkett North America

Technical Services Department

30000 Aurora Road

Solon, Ohio 44139

800.899.8916

info@tarkettna.com

www.tarkettna.com